

Model: Wilson

Product inform.



dated 06/2022



Corner element left - 2-seater with armrest right



Longchair with armrest left - 2-seater without armrests - corner element right



Longchair big with armrest left - 1,5-seater with armrest right



[www.blauer-engel.de/uz148](http://www.blauer-engel.de/uz148)



Longlife by 3C Care

**Model: Wilson**

## **Checklist**

---

### **So you won't forget any of our choices...**

Please use this checklist in order to discuss all options with your customer.

### **An absolute must**

The following options must be considered for this model (please always mention with your order):

Seat height

Legs

### **Functions**

Have you explained to your customer the advantages of the following functions?

seat extension motorized

### **Accessories**

Have you informed your customers about the selection of our accessories?

Stool

Cushion

Model: Wilson



## Product and ordering information

---

**Frame:** Load-bearing parts of the frame made of solid wood and wood materials, surfaces lined with padded cover.

**Seat:** Spring system with permanently elastic steel sinuous springs and an upper-side cover. Seat made of PUR foam (min. RG 35), structured in layers in different thicknesses and hardness. Seat covered with cotton wool fleece. (Illustration see „Cross sections and ordering information“)

**Upholstery:** Soft, loose upholstery structure, in which a model-related or design-related wave formation of the covers, as well as seat impressions, are typical for the product. The upholstery will adapt to the body shape or the seat firmness will slightly decrease. Minor differences in the seat firmness in the case of add-on assemblies are due to the design and are therefore no reason for complaint.

**Back:** Back made of ergonomically shaped PUR foam (min. RG 25). Cover made of cotton wool fleece.

**Seat height:** 40 cm Seat height  
43 cm Seat height



**Dimensions:** Total height at seat height 40 cm: **69-82 cm**  
Total height at seat height 43 cm: **72-85 cm**  
Depth: **107-110 cm**  
Depth with seat extension: **125-128 cm**  
Seat height: **40 / 43 cm**  
Seat depth: **70 cm**  
Seat depth with seat extension: **88 cm**

**Decorative fabric:** The decorative fabric (decorative fabric PG 6 / decorative fabric PG 10) is only available for selected types (Stool, flutter cushions and cushions) and pattern matching is not possible. The prices can be found on PG 6 or PG 10.

Model: Wilson



## Product and ordering information

---

**Miscellaneous:** The corner element big always consists, due to transport, of 2 parts (divided in the middle).

All materials used meet the requirements of the DGM according to RAL GZ 430. The seam distribution may vary with fabric, leather or imitation leather processing. The definition of quilted mats and cushions depend on the design and structure. The appearance of decorative, fell and double seams may vary depending on the fabric, leather and artificial leather used.

All backrest tensioning parts are supplied as standard in their respective original covers. Material-related information can be found in our fabric and leather flaps on the back with the individual fabric and leather qualities.

All values stated in the price list are approximate measurements in centimetres, determined by the usual measuring method (see RAL-GZ 430) and in unused new condition.

Please note that with very casual upholstered furniture in the course of use especially in the seat height and seat depth noticeable deviations from the dimensions given here can occur. We reserve the right to make changes in form, colour and construction in the course of technical progress.

**Please always order from left to right as standing in front of the suite!**

Model: Wilson



## cross sections and ordering informations

Seat: sandwich structure / Back: foam

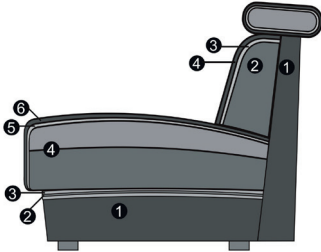

### Seat

1. frame
2. zigzag springs
3. zigzag spring cover
4. sandwich structure (fixed marked seat)
5. cotton wadding cover
6. cover material

### Back

1. frame
2. foam (fixed back)
3. cotton wadding cover
4. cover material

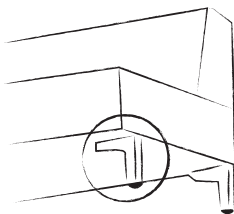

Foot position for elements without function

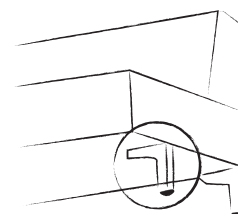

Foot position for elements with function  
The foot is ap. 2 cm moved backwards

Model: Wilson



## Foot selection

---



**781** (SH 40 cm)  
**782** (SH 43 cm)  
chrome plated



**799** (SH 40 cm)  
**798** (SH 43 cm)  
Chrome matt



**237** (SH 40 cm)  
**236** (SH 43 cm)  
black matt



**747** (SH 40 cm)  
**748** (SH 43 cm)  
Wooden leg

### Notes feet:

Wood foot-colour:

Please take the wood foot colours from the wood sample card! (with special color oiled oak)  
Please note: we charge a surcharge for the oiled oak base!

Foot position  
for elements  
without function:

Please consider that the feet of the elements 1,5-seater in combination with the function  
„Seat extension motorized“ due to technical reasons must be placed deeper under the set  
as at elements without function.

---

Model: Wilson



## Functions

---

### Headrest adjustment:

All elements with variable headrest adjustment (manual) at no extra charge. The headrest adjustment helps you to achieve a comfortable sitting position. The headboards can be tilted or raised to suit your individual needs. So: lean back and relax!

### seat extension motorized:

With the motorised seat depth adjustment you can change the seat depth of your sofa with the touch of a button. Types with this function are equipped with a touch control switch. Elements with the „motorised seat depth adjustment“ function are equipped with a concealed switch which must be operated for moving. The relevant operating instructions are enclosed with the furniture.



Inclusive Headrest adjustment



Seat depth extension



Touch control switch

Model: Wilson



Cord

**This model is also available in Cord (PG Cord)**

PG Cord is confirmed on the order confirmation. For prices, please refer to price group 6.

**For thread course for corduroy, see Picto.**

Not every model has the types shown or other types. This is ONLY an excerpt!  
Please refer to the type plan of the desired model for the type selection.

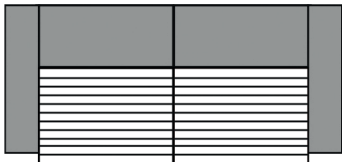

3-seater/1-seater+end-element etc.

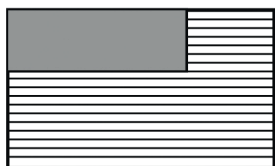

Longchair

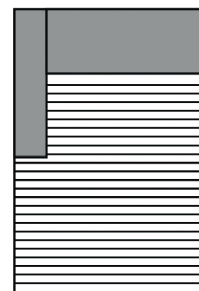

corner element

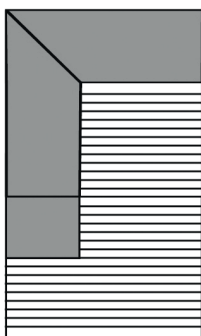

angular corner

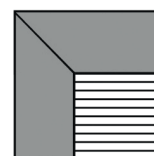



Model: Wilson



**All articles at a glance**  
(without types with function and accessories)

Single elements with armrest left / right					
2-seater with armrest left / right	1,5-seater with armrest left / right				
175 cm	140 cm				

Single elements without armrests					
2-seater without armrests	1,5-seater without armrests				
140 cm	105 cm				

Basic elements					
longchair with armrest left / right	longchair large with armrest left / right	corner element left / right	corner element large left / right	angular corner small	
105 x 178-181 cm	140 x 178 - 181 cm	107-110 x 213-216 cm	143-146 x 213-216 cm	106 - 109 cm	

In between stool and end stool					
in between stool	end stool left / right	in between stool large	end stool large left / right		
72 x 107 cm	72 x 107 cm	107 x 107 cm	107 x 107 cm		

Model: Wilson

Combinations

For production reasons, the rectangular end pieces cannot be combined with other elements!  
Possible combination: REABL - REABR

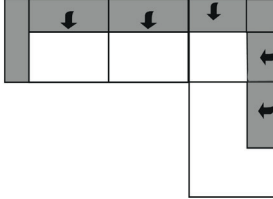
Dimensions(ap.cm) Height: 69-82/72-85 Depth: 107-110 Depth SV: 125-128 Seat height: 40/43 Seat depth: 70 Seat depth SV: 88			
item No.	8323	8672(Abb.) / 8673(spiegelbildl.)	
Dimensions	286 - 292 cm	318 - 321 cm x 213 - 216 cm	
	rectangle end element left - rectangle end element right	2-seater with armrest left - corner element right large	
Prices in EUR			
price group 2 / 6	-	-	
price group 3 / 8	-	-	
price group 4 / 10	-	-	
price group 5 / 12	-	-	
price group C / D	-	-	
price group H / L	-	-	
price group J	-	-	
price group T	-	-	

Surcharges

Model: Wilson



Single elements

Dimensions(ap.cm) Height: 69-82/72-85 Depth: 107-110 Depth SV: 125-128 Seat height: 40/43 Seat depth: 70 Seat depth SV: 88				
	item No.	2001 / 2003	7421 / 7423	2000
Dimensions	175 cm	175 cm	140 cm	140 cm
	2-seater with armrest left / right	2-seater with armrest left / right with motorized seat extension	2-seater without armrests	2-seater without armrests with motorized seat extension
<b>Prices in EUR</b>				
price group 2 / 6	-	-	-	-
price group 3 / 8	-	-	-	-
price group 4 / 10	-	-	-	-
price group 5 / 12	-	-	-	-
price group C / D	-	-	-	-
price group H / L	-	-	-	-
price group J	-	-	-	-
price group T	-	-	-	-

Surcharges

Model: Wilson



Single elements

Dimensions(ap.cm) Height: 69-82/72-85 Depth: 107-110 Depth SV: 125-128 Seat height: 40/43 Seat depth: 70 Seat depth SV: 88				
item No.	7151 / 7153	7991 / 7993	7150	7200
Dimensions	140 cm	140 cm	105 cm	105 cm
	1,5-seater with armrest left / right	1,5-seater with armrest left / right with motorized seat extension	1,5-seater without armrests	1,5-seater without armrests with motorized seat extension
Prices in EUR				
price group 2 / 6	-	-	-	-
price group 3 / 8	-	-	-	-
price group 4 / 10	-	-	-	-
price group 5 / 12	-	-	-	-
price group C / D	-	-	-	-
price group H / L	-	-	-	-
price group J	-	-	-	-
price group T	-	-	-	-

Surcharges



Model: Wilson



Basic elements

The large conversion corner type 7911 or 7634 always consists of 2 parts (split in the centre 7525/7526 or 7425/7527) for transport reasons.

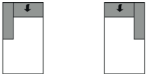
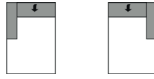
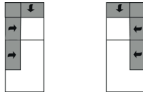
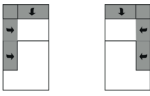
For technical production reasons, we must inform you that no combinations such as LAL-LAR / LAL large-LAR large / UBEL-UBER / UBELlarge-UBERlarge or pointed corner small - pointed corner small can be placed, as this would result in gaps.

Dimensions(ap.cm) Height: 69-82/72-85 Depth: 107-110 Depth SV: 125-128 Seat height: 40/43 Seat depth: 70 Seat depth SV: 88				
item No.	7121 / 7123	7921 / 7923	7111 / 7113	7911 / 7634
Dimensions	105 x 178-181 cm	140 x 178 - 181 cm	107-110 x 213-216 cm	143-146 x 213-216 cm
	longchair with armrest left / right	longchair large with armrest left / right	corner element left / right	corner element large left / right
Prices in EUR				
price group 2 / 6	-	-	-	-
price group 3 / 8	-	-	-	-
price group 4 / 10	-	-	-	-
price group 5 / 12	-	-	-	-
price group C / D	-	-	-	-
price group H / L	-	-	-	-
price group J	-	-	-	-
price group T	-	-	-	-

Surcharges



**Model: Wilson**



## Basic elements

The large conversion corner type **7911** or **7634** always consists of 2 parts (split in the centre 7525/7526 or 7425/7527) for transport reasons.

For technical production reasons, we must inform you that no combinations such as LAL-LAR / LAL large-LAR large / UBEL-UBER / UBELlarge-UBERlarge or pointed corner small - pointed corner small can be placed, as this would result in gaps.

Dimensions(ap.cm) Height: 69-82/72-85 Depth: 107-110 Depth SV: 125-128 Seat height: 40/43 Seat depth: 70 Seat depth SV: 88				
item No.	7120			
Dimensions	106 - 109 cm			
	angular corner small			
<b>Prices in EUR</b>				
price group 2 / 6	-			
price group 3 / 8	-			
price group 4 / 10	-			
price group 5 / 12	-			
price group C / D	-			
price group H / L	-			
price group J	-			
price group T	-			





### Surcharges

**Model: Wilson**



**in between stool and end stool**

**When ordering, please make sure to specify whether the end stool, in the desired combination, should be mounted on the left or right-standing in front of it!**





Dimensions(ap.cm) Height: 69-82/72-85 Depth: 107-110 Depth SV: 125-128 Seat height: 40/43 Seat depth: 70 Seat depth SV: 88				
item No.	7735	7742 / 7748	7115	7628 / 7629
Dimensions	72 x 107 cm	72 x 107 cm	107 x 107 cm	107 x 107 cm
	in between stool	end stool left / right	in between stool large	end stool left / right large
<b>Prices in EUR</b>				
price group 2 / 6	-	-	-	-
price group 3 / 8	-	-	-	-
price group 4 / 10	-	-	-	-
price group 5 / 12	-	-	-	-
price group C / D	-	-	-	-
price group H / L	-	-	-	-
price group J	-	-	-	-
price group T	-	-	-	-

**Surcharges**

Model: Wilson



Stool / accessories

Dimensions(ap.cm) Height: 69-82/72-85 Depth: 107-110 Depth SV: 125-128 Seat height: 40/43 Seat depth: 70 Seat depth SV: 88				
item No.	9599	7853	7854	7804
Dimensions	71 x 71 cm	71 x 107 cm	107 x 107 cm	40 x 40 cm
	stool medium	stool bench	stool	cushion
Prices in EUR				

price group 2 / 6	-	-	-	-
price group 3 / 8	-	-	-	-
price group 4 / 10	-	-	-	-
price group 5 / 12	-	-	-	-
price group C / D	-	-	-	-
price group H / L	-	-	-	-
price group J	-	-	-	-
price group T	-	-	-	-





Surcharges



Model: Wilson



Accessories

Dimensions(ap.cm) Height: 69-82/72-85 Depth: 107-110 Depth SV: 125-128 Seat height: 40/43 Seat depth: 70 Seat depth SV: 88				
item No.	7805	7806	7546	7545
Dimensions	50 x 50 cm	60 x 60 cm	75 x 75 cm	95 x 95 cm
	cushion	cushion	flutter cushion square M	flutter cushion square L
Prices in EUR				
price group 2 / 6	-	-	-	-
price group 3 / 8	-	-	-	-
price group 4 / 10	-	-	-	-
price group 5 / 12	-	-	-	-
price group C / D	-	-	-	-
price group H / L	-	-	-	-
price group J	-	-	-	-
price group T	-	-	-	-

## Goldenes M & Emissionslabel

### Are you demanding? That's fine - we are too!

Therefore, we attach great importance to durability, material quality, longevity, safety and health tolerance!

Because our furniture meets the high standards of the Gütegemeinschaft Möbel e.V., our entire product range is awarded the quality mark „Golden M“ and the highest possible emission class A.



### Quality mark „Goldenes M“

Nearly 50 years of research, laboratory tests, field tests, comparisons and scientific exchange is behind the RAL quality mark „Goldenes M“.

- Tested quality according to quality and test regulations RAL-GZ 430
- Guaranteed safety through elaborate laboratory and functional tests
- Healthy living through strict limits for pollutants - sometimes more stringent than the law requires, which were determined in independent test laboratories

The „Goldenes M“ means for the furniture buyer: This is quality, you can rely on.



### Emission label

An expert group of the Deutsche Gütegemeinschaft Möbel e.V. has developed in collaboration with leading test institutes such as TÜV Rheinland, the LGA Nuremberg and the ECO Institute an Emission label for furniture.

- The label gives the consumer information about pollutant emission and should protect him from health protect impairments
- The entire range is classified according to these guidelines
- The proof of classifications is based on compliance of the awarding basis with appropriate pollutant tests from neutral testing institutes based on the requirements of RAL-GZ 430 or the Blue Angel's.

Our products meet the highest emission class „A“, which gives us a clear conscience and you a maximum of safety with regards to the emission levels of your upholstery.

Model: Wilson

blue angel and longlife



## Are you demanding? That's fine - we are too!

Especially in the leather area, a responsible approach to the environment and health is very important for us.. Our leathers have been awarded the „Blue Angel“ because we specifically select upholstery leathers for our furniture that are harmless to health.

So that our customers can enjoy their leather furniture for a long time, we now offer the possibility to take out an additional 5-year service up to 4 weeks after purchasing the furniture.



[www.blauer-engel.de/uz148](http://www.blauer-engel.de/uz148)

### Blue Angel - environmentally friendly upholstery leather

The Blue Angel for low-emission upholstery leather signals that the excellent leathers minimize the environmental and health burdens from production over the entire daily use to recycling and disposal. The following leather qualities are awarded with the Blue Angel:

Cento  
Dickleder Torero  
Life-Line  
Vicenza



**The Blue Angel is the world's most successful eco-label with a brand awareness of 92%!**

### 5-Year-Longlife-Service

With the right cleaning and care products you keep the value of your upholstered furniture and enjoy it for a long time. As part of this 5-Year LONGLIFE-Service, you will receive professional phone support, free special products and free support.

The Service can be completed for the following leather qualities:

Cento  
Dickleder Torero  
Mercury  
Vicenza

Longlife

by 3C Care



**5-Year-LONGLIFE-Service provides security for a upholstery leather that is particularly durable and easy to care for!**

For more information please see [www.3c-care.de](http://www.3c-care.de)

Model: Wilson



## OEKO-TEX® STANDARD 100 + klimaneutraler Hersteller

### What is OEKO-TEX®?

Many of our fabrics and upholstery materials have been awarded the STANDARD 100 by OEKO-TEX® label. If a textile article has been awarded this label, you can be sure that this fabric or upholstery material has been tested for harmful substances and the article is therefore harmless to health.

You can find information on which of our upholstery fabrics are certified and other helpful information on our homepage at <https://www.candy-polstermoebel.de/bezuege/stoffe/>

The award offers you the following advantages:

- STANDARD 100 by OEKO-TEX® is one of the world's most renowned labels for textiles tested for harmful substances. It stands for customer confidence and high product safety.
- The testing is carried out by independent OEKO-TEX® institutes on the basis of a comprehensive OEKO-TEX® criteria catalogue.
- The test procedure takes into account many substances, both regulated and non-regulated, that could be harmful to human health.
- In many cases, the limit values set for the STANDARD 100 go beyond national and international standards.
- The catalogue of criteria is updated at least once a year and expanded to include new scientific findings or legal requirements.



(example label)

### We are a climate-neutral furniture manufacturer (on balance sheet and through CO<sub>2</sub> certificates)

We can proudly say that we have been awarded as a climate-neutral manufacturer by the DGM. Our actions are always oriented towards the careful use of resources in order to protect and preserve the livelihoods of people, animals and plants. For 3C, sustainability is not just an advertising promise - the development of sustainable products is a matter of course for us.



Model: Wilson

EU guidelines



---

**WEEE-Reg.-Nr. DE 22661937**

Informationspflichten gemäß §18 Abs. 2 Elektro- und Elektronikgerätegesetz:

<https://www.bmu.de/themen/wasser-abfall-boden/abfallwirtschaft/statistiken/elektro-und-elektronikaltgeraete/>